

Installation Guidelines

For All Quaker Window Products with nail fin

Installer:

- **Read these instructions completely before starting any installation.** Failure to install and maintain our product according to these instructions will void any warranty, written or implied.
- These instructions are consistent with ASTM 2112 “Standard Practice for Installation of Exterior Windows, Doors and Skylights” into common wall constructions. Contact your architect or construction professional for installation into other building designs or constructions methods.
- The installer is responsible for consulting the contractor, structural engineer, architect, or consumer, for proper installation according to local codes and/or ordinances.



Warning:

- Proper eye and hearing protection must always be worn when installing, removing or performing adjustments to Quaker window and door products.
- Use power tools properly! To avoid personal injury, always follow manufacturers’ instructions for safe operation of power tools.
- If broken, glass can fragment causing injury. All Quaker products are available with safety glass. In many areas, local building codes require safety glass in certain locations and/or applications. Unless Quaker’s stipulations dictate safety glass or safety glass is specifically ordered, Quaker windows are not provided with safety glass. Before installing, Quaker recommends consulting local building codes for more definitive information.

Caution:

- Lead-based paint may be present in older homes, and the removal of windows may cause this paint to be disturbed. In order to minimize exposure to lead-based paint dust, please consult www.epa.gov/lead.
- Care must be taken to properly recycle or dispose of old materials. Any recyclable materials should be separated from non-recyclable or hazardous materials. Please consult with local or state authorities regarding proper disposal of non-recyclable or hazardous materials.
- Some codes require the use of pressure treated lumber to line rough openings. Corrosion resistant materials, such as stainless steel or hot-dip galvanized steel, must be used for fasteners and anchors having direct contact with pressure treated lumber.

Important:











- Quaker reserves the right to change the information contained in these guidelines without notice.
- Maintain a minimum of ¼” between the exterior window frame and any trim, siding or masonry to allow for expansion.
- Window nailing flanges and drip caps (integral or applied) do not take the place of window flashing. All windows and doors must be properly flashed and sealed around the perimeter.
- Use of Quaker products in barrier EIFS systems (synthetic stucco) is not recommended. To do so will void all warranties (written or implied) and Quaker Window Products Co., Inc. will not be held responsible for any claims or damages resulting from water infiltration.
- Do not drill through window sill to install alarm wires.
- If using muriatic acid or brick wash cleaning solutions, please follow the manufacturer’s instructions found on the product label or on the manufacturer’s website.

Handling and Storage:

- Do not store units outside, or in a hot environment.
- When carrying window, always keep it in a vertical position. **Do not carry flat**, doing so could result in damage to the unit.
- Stack units as straight as possible to avoid bowing. Do not lay flat!

These instructions are for installing all of Quaker Window Products with nail fin into a wood or concrete/masonry wall. The rough opening must be lined with a 1 ½” thick wood buck. Contact your Quaker window and door supplier for more information on installing units in other wall conditions. Please visit our website at www.quakerwindows.com or call at 1-800-347-0438 for additional literature and information.

Tools required by installer:

- Safety Glasses 
- Hearing protection 
- Utility knife 
- Hammer 
- Caulk Gun 
- Level 
- Square 
- Tape measure 
- Stapler 
- Ladder / Scaffolding 

Materials required by installer:

- Backer Rod
 - ¼” to ½” diameter closed cell foam
- Insulation
 - Fiberglass or similar strips
 - Minimally expanding low pressure polyurethane window and door spray foam. **(Must be compliant with AAMA 812-04)**
- Shims
 - Made of cedar or synthetic material
- Roofing Nails
 - 2” galvanized (8D)
- Silicone Sealant
 - 100% silicone ASTM C920 compliant
 - Neutral cure (modified oxime) only
 - Some sub-states made need to be primed before sealed. Consult the sealant supplier.
- Flashing
 - Self-adhesive flexible flashing that complies with ASTM-D779

Step 1: Inspect unit before installation

- A. Remove all shipping packaging material (blocks, pads, protectors, stretch wrap) and dispose/recycle properly.
- B. Inspect unit for any damage or defects, and make sure the unit operates properly.
- C. Verify that the window unit is the correct size and configuration.
- D. Contact the nearest Quaker distributor if there is a problem. Provide the sales order number on the warranty sticker (see <http://quakerwindows.com/wp-content/uploads/2013/04/Warranty-sticker-locations01-30-2015.pdf> for sticker locations).

Step 2: Prepare rough opening

- A. The material/lumber quality and fasteners must be structurally adequate for design load requirements.
- B. Measure and verify the size of the rough opening. The rough opening should be a minimum 1/2" (but not to exceed 1") wider and taller than your unit. The masonry opening should be sized 1/2" wider and 9/16" higher than the units exterior frame.
- C. Verify the rough opening is flat, plumb, level, and square. (Fig. 1)
 - Take diagonal measurements to check for square.
 - The sill plate beneath the unit must be level for proper unit operation.
- D. Cut the weather-resistant barrier (WRB) in a "1" pattern. (Fig. 2)
 - Fold back the WRB sides and sill toward the interior and staple into place. (Fig. 3)
- E. Cut the top corners of the WRB at 135° and 9" long. (Fig. 2)
 - Fold flap up and temporarily tape in place. (Fig. 4)

CAUTION

- When installing into a wall with exterior rigid foam insulation panels, place solid blocking material behind the nail fin to provide proper support when fastening the unit.

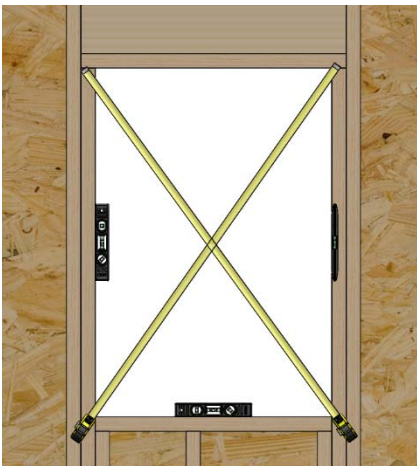

Fig. 1

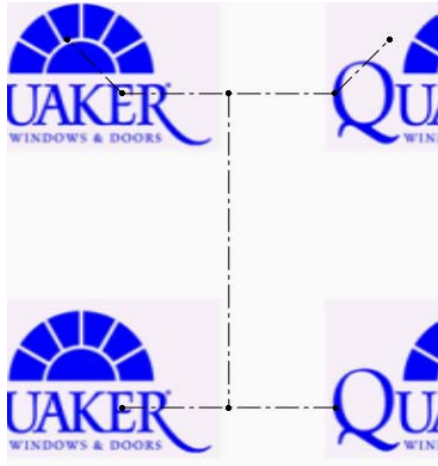

Fig. 2

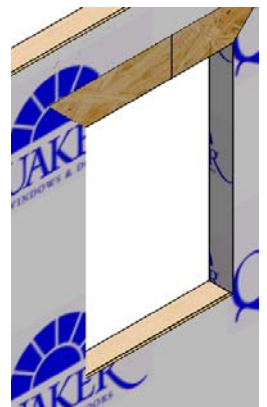

Fig. 3

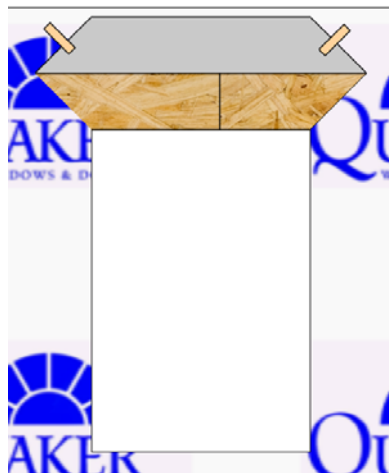

Fig. 4

Step 3: Sill Flashing (If using QWP sill pan flashing system go to step 3 on the sill pan flashing installation guide that came with the sill pan flashing kit)

- A. Flashing must meet ASTM-D779 performance requirements.
 - Use flashing that is 6" minimum in width
 - When using WRB and OSB substrates, or with applications under 45°F, spray an application adhesive (available at you Quaker dealer) around the perimeter of the window before applying flashing. Different applications require different spray adhesives so please check with your dealer for the proper type.
- B. Measure the width of rough opening and cut a length of flashing that is 12" wider than the rough opening. This will allow you to run the flashing 6" up each side. (Fig. 5)
- C. Apply sill flashing to exterior side first allowing for a minimum of 3" of flashing to be below the sill, and a minimum of 6" up each side. (Fig. 5)
- D. Flashing tape must cover the entire sill plate. If needed, apply an additional flashing piece over the first one (start from the exterior and work toward the interior). Maintain a minimum 1" overlap.

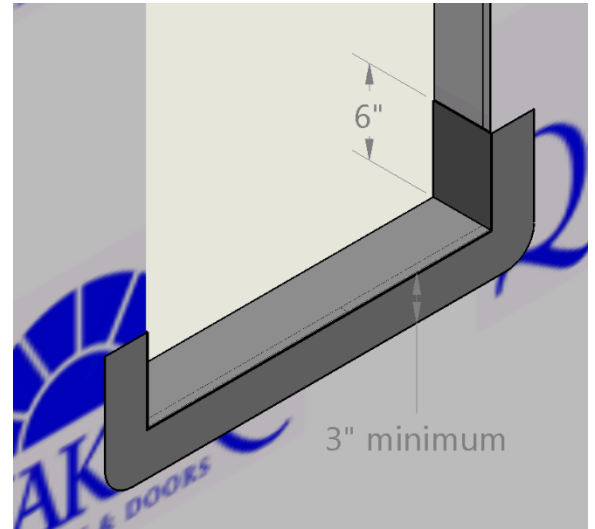

Fig. 5

Step 4: Window Installation

- A. Apply a ¼" diameter bead of 100% neutral cure silicone sealant along the backside of the nailing flange.
 - Bead must run continuously around both sides and across the head, in line with and completely covering the nailing flange holes. (Fig. 6)
- B. Make sure window is closed and locked before setting the window. Center and set the window into the rough opening, making sure there are equal gaps on both sides of the window.
- C. Temporarily tack the window into place using 2" galvanized roofing nails through the pre-punched hole on one top corner of nailing flange. Do not drive the nail in fully. (Fig. 7)

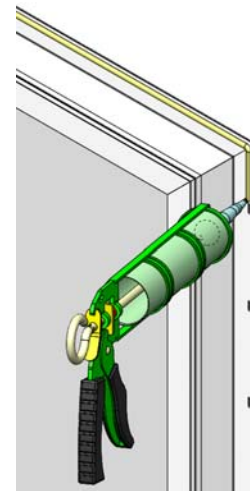

Fig. 6

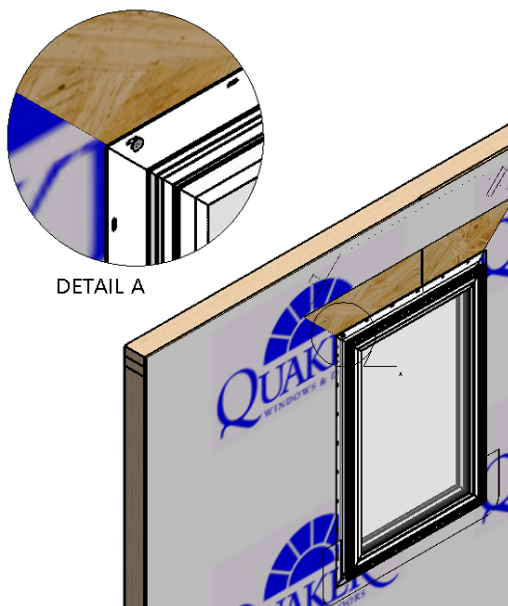



Fig. 7

Step 4: Window Installation (cont.)

- D. Level at the sill and plumb the frame (interior/exterior). Shim under the frame to bring to level if necessary. (Fig. 8)
 - E. From the interior, square the frame in the opening by installing shims between the jambs and framing 4"-6" from the head jamb and sill. Measure the diagonals and adjust shims until the unit is square in the opening. (Fig. 8)
 - F. Now tack the lower corners of the nailing fin and recheck for square. If necessary remove the nails and adjust shims until the unit is square.
 - G. Once square install additional shims at 16" intervals on center and at each lock point. Always shim at check rails and meeting stiles. (Fig. 9)
 - H. Measure at head jamb, center of unit, and sill to make sure all dimensions are equal. If they are not, you will have to adjust the shims accordingly. (Fig. 10)
 - I. Once the unit is square and plumb in the opening, operate the sash (on operable units) to make sure it is operating properly. If not, you may have to make some adjustments to the shims.
-  **Tip:** On operating units, one way to make sure that the unit is installed square is to check the reveal (gap) between the operating sash and the frame. An even reveal around the entire sash generally means a squarely installed unit and will ensure smooth operation.
- J. Complete fastening of the nailing fin around the perimeter of the unit with 2" roofing nails 2" from each corner and spaced every 6"-8" on center. **Do not nail each hole.**

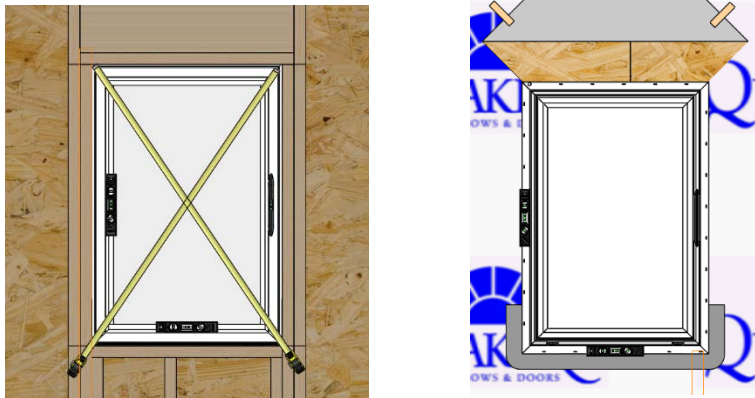

Fig. 8



Fig. 9

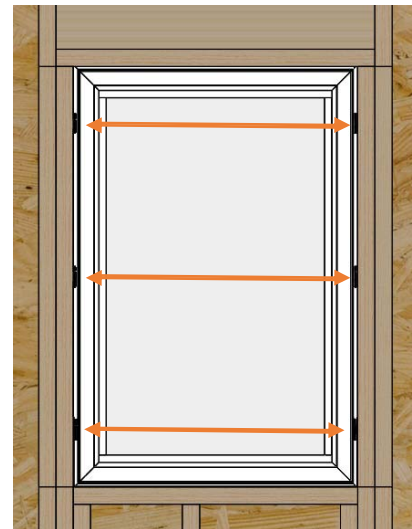

Fig. 10

Step 5: Exterior flashing

- A. Cut two pieces of flashing tape for jamb flashing extending 1" above window head flange and 4" to 6" below bottom edge of sill flashing. Remove release paper and press tightly along sides of window frame. (Fig. 11)
- B. Cut a piece of flashing tape for the head flashing, which extends beyond outer edges of jamb flashings. Remove release paper and install completely covering mounting flange and adhering to exposed sheathing or framing members. (Fig. 12)
- C. Flip down upper flap of WRB so it lays flat across head flashing, then **trim 1"– 2" above the window opening.**
- D. Tape along all cuts in WRB and across head of the window with flashing tape. (Fig. 13)

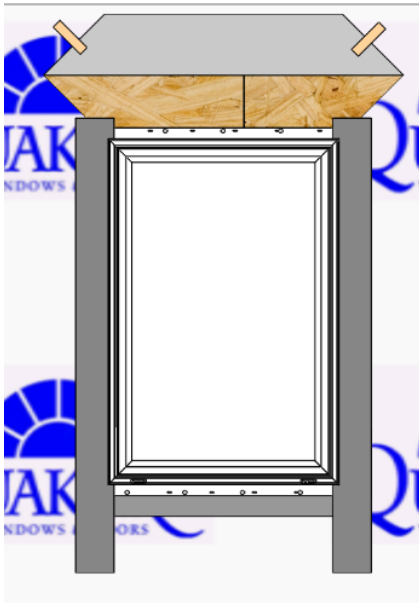

Fig. 11

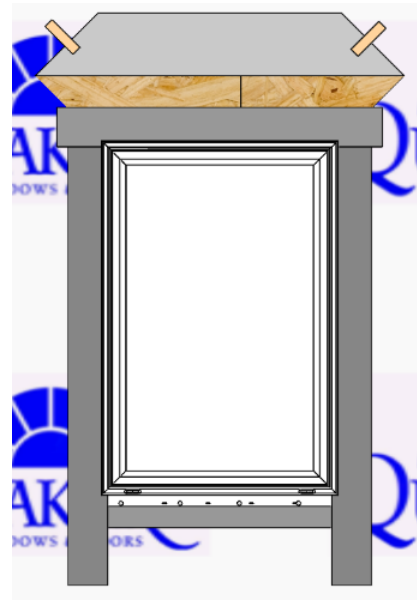

Fig. 12

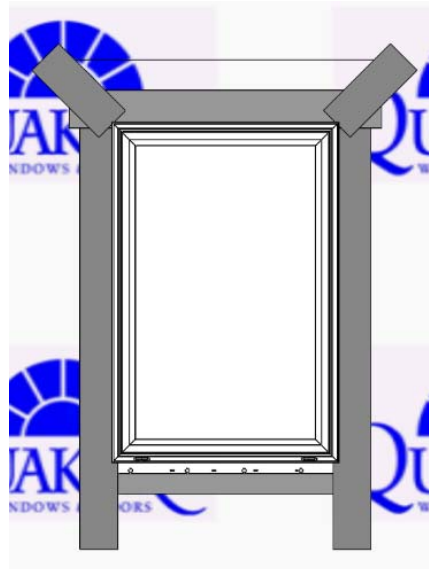
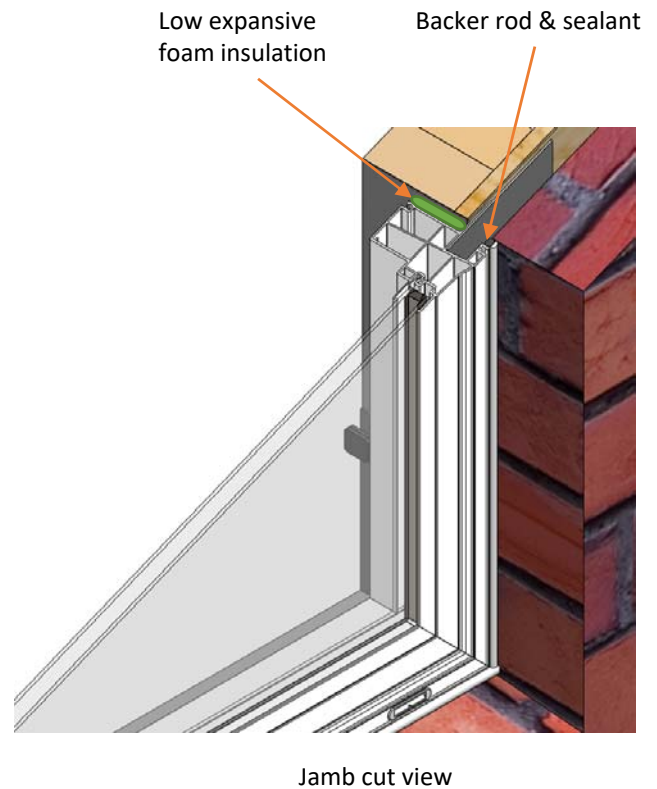
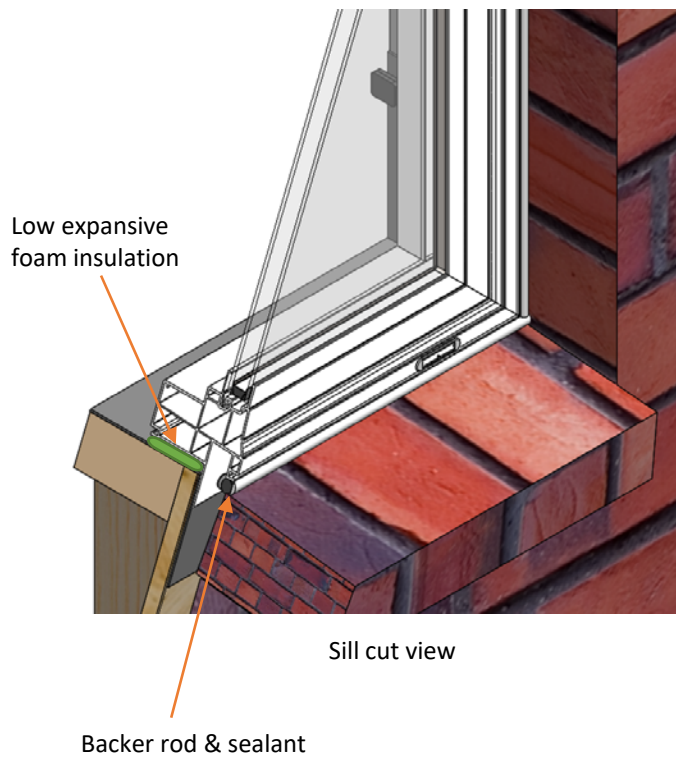

Fig. 13

Step 6: Sealing the Exterior

- A. **Warning:** Maintain a minimum of ¼” between the window frame, trim, siding, or masonry. Failure to do so will forfeit all warranties (written or implied).
- B. After siding or wall exterior is complete, apply backer rod and sealant between the window frame and exterior finish material on all four sides of unit. Make sure to clean all surfaces before applying 100% neutral cure silicone sealant.
 - Note: For windows that have an integral J-channel frame, this step is not needed when using siding that tucks behind the J-channel frame. For windows that utilize a J-channel as an addition to the frame, the backer rod and sealant must be applied as shown below before application of J-channel.



Step 7: Complete the Interior

- A. Insulate between the window frame and the rough opening using loose fiberglass insulation or minimally expanding window and door spray foam insulation that is compliant with AAMA 812-04. Read and follow the manufacturers' recommendations for application and use.
- B. Operate window unit to ensure proper operation. Sash will not operate correctly if window is out of square, over-shimmed or over-insulated.
- C. Allow foam to fully cure before installing interior trim.
- D. If using the QWP sill pan flashing make sure to complete step 7b of the sill pan flashing installation guide.

Care and Use

An inspection of your windows should be made annually. Visit the Quaker website <http://quakerwindows.com/wp-content/uploads/2013/05/Quaker-Window-Care-Maintenance.pdf> or contact your local independent Quaker distributor for information on the care and use of your product. Ask for the Window Care & Maintenance Guide.